

Hanging Lite

Cat. No. HL

Cat. No. HLGU



The Hanging Lite is a single spotlight which can be easily hung from high vantage points, including trees, fences and overhangs, providing a dramatic wash lighting effect. The luminaire is machined from a choice of 10mm thick aluminium with a UV stable powder coated finish, solid copper or 316 stainless steel with a clear, tempered, flush glass lens and high temperature silicon gaskets. This luminaire comes standard with a 3 meter cable and stainless steel wire.

A GU10 version of this luminaire is also available for line voltage lamps. However, a longer body is needed to accommodate the longer lamp.

Ordering Information

Luminaire Type

HL - Hanging Lite
HLGU - Hanging Lite
GU10

Material/Finish

BK - Black
BZ - Bronze
CT - Corten
DG - Dark Grey
OG - Olive Green
STAR - Silver Star
WB - White Birch
WH - White
COP - Copper
SS - Stainless Steel

Accessories

CJK150 - Cable Joint Kit
GG - Glare Guard
HCL - Hex Cell Louvre
LENSSTEPF - Frosted Lens

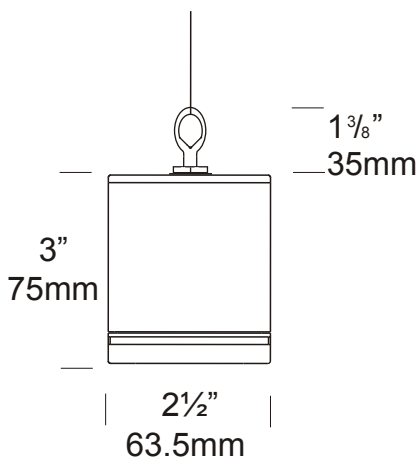

Ordering Example: HL BK - Hanging Lite in Black
HLGU COP - Hanging Lite GU10 in Copper
GG SS - Glare Guard in Stainless Steel
(accessories ordered separately)

HUNZA™ PURE
OUTDOOR
LIGHTING

HUNZA FACTORY
130 Felton Mathew Ave
Glen Innes
Auckland 1072
New Zealand

Ph: 64-9-528 9471
Fax: 64-9-528 9361
hunza@hunza.co.nz
www.hunzalighting.com

INTERNATIONAL CONTACTS:
[http://www.hunzalighting.com/
contact.php](http://www.hunzalighting.com/contact.php)
Specification may change without notice.
Manufactured in New Zealand.
© 2016 Hunza Holdings Ltd.

Luminaire Construction

CNC machined from one of the following metals:

Aluminium

High corrosion resistant aluminium with chromate substrate and high UV resistant polyester powder coat.

Body: 63.5mm (2½") x 10mm (3/8") tube.

End cap: solid aluminium 63.5mm (2½") rod.

Colours:

Black, Bronze, Corten, Dark Grey, Olive Green, Silver Star, White, White Birch.

Copper

Body: 63.5mm (2½") x 10mm (3/8") tube.

End cap: solid copper 63.5mm (2½") rod.

316 Stainless Steel

Body: 63.5mm (2½") x 10mm (3/8") tube.

End cap: solid stainless steel 63.5mm (2½") rod.

Features

Lens

10mm (3/8") clear flush fit shatter resistant glass.

Lifetime Warranty.

Gasket

Silicone, iron impregnated 220°C (428°F).

Lamp Holder

MR16 & GU10 - 350°C (662°F)
ceramic multi contact lamp holder with 250°C (480°F) Teflon cables.

Accessories

Cable Joint Kit (Cat. CJK150). Not approved for USA/Canada.

Glare Guard (Cat. GG).

Hex Cell Louvre (Cat. HCL).

Frosted Lens (Cat. LENSSTEPF).

Standards

IP68, UL1838, 

Luminaire Weight

Aluminium - 0.700kg (1lb 9oz)

Copper - 1.470kg (3lb 4oz)

Stainless Steel - 1.160kg (2lb 9oz)

Power Supply

Hunza Inground or Wall Mount

Transformer: not included.

USA and Canada

Hunza Wall Mount Transformer: not included.

Lamp Options

MR16 - 20 or 35 watt lamp max.

GU10 - 25 or 35 watt lamp max.

USA and Canada

MR16 - 20 watt lamp max.

GU10 - lamp not supplied.

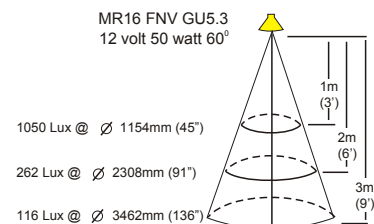
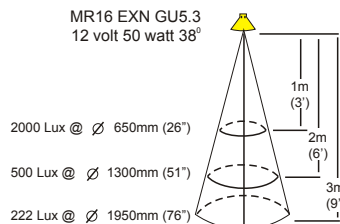
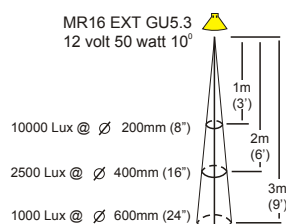
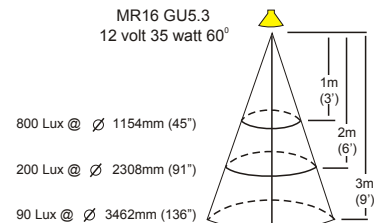
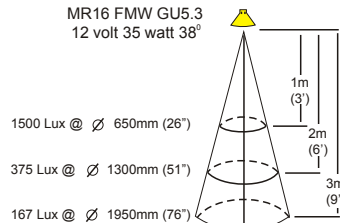
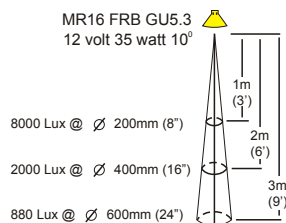
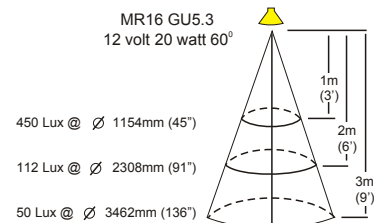
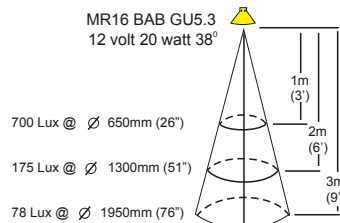
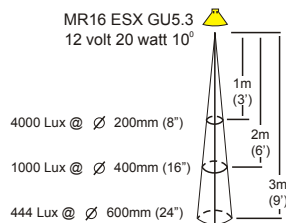

HUNZA™ PURE OUTDOOR LIGHTING

HUNZA FACTORY
130 Felton Mathew Ave
Glen Innes
Auckland 1072
New Zealand

Ph: 64-9-528 9471
Fax: 64-9-528 9361
hunza@hunza.co.nz
www.hunzalighting.com

INTERNATIONAL CONTACTS:
<http://www.hunzalighting.com/contact.php>
Specification may change without notice.
Manufactured in New Zealand.
© 2016 Hunza Holdings Ltd.