

Single Pole Lite

Cat. No. SPL

Cat. No. SPL/R

Cat. No. SPLGU



The Single Pole Lite has an individual spotlight which can be aimed in any direction. The fixture is ideal for path lighting as well as tree lighting, or the head may be aimed downward to eliminate vertical light. The fitting has a fully adjustable arm allowing 360 degree rotation and 0 - 90 degree elevation.

The Retro™, which is a mains option, avoids the need to bury a transformer. The 110/240-12 volt electronic transformer is built into the pole and is a double insulated safety isolating transformer, this changes the luminaire to an IP56 rating.

A GU10 version of this luminaire is also available for line voltage lamps.

Ordering Information

Luminaire Type

SPL - Single Pole Lite
 SPL/R - Single Pole Lite Retro
 SPLGU - Single Pole Lite GU10

Material/Finish

BK - Black
 BZ - Bronze
 CT - Corten
 DG - Dark Grey
 OG - Olive Green
 STAR - Silver Star
 WB - White Birch
 WH - White
 COP - Copper
 SS - Stainless Steel

Accessories

CJK150 - Cable Joint Kit
 GG - Glare Guard
 HCL - Hex Cell Louvre
 LENSSTEPF - Frosted Lens

Ordering example: SPL BK - Single Pole Lite in Black
 SPL/R COP - Single Pole Lite Retro in Copper
 SPLGU SS - Single Pole Lite GU10 in Stainless Steel
 LENSSTEPF - Frosted Lens
 (accessories ordered separately)

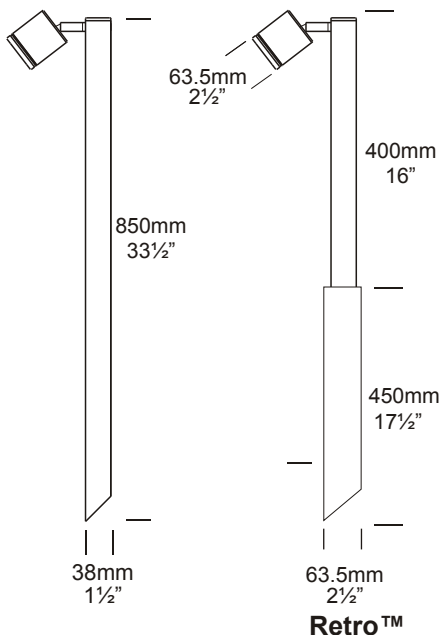

Retro™

Luminaire Construction

CNC machined from one of the following metals:

Aluminium

High corrosion resistant aluminium with chromate substrate and high UV resistant powder coat.

Body: 63.5mm (2½") x 10mm (3/8") tube.
End cap: solid aluminium 63.5mm (2½") rod.

Pole: 38.1mm (1½") x 850mm (33½") aluminium tube.

Retro pole: 38.1mm (1½") x 400mm (15¾") and 63.5mm (2½") x 450mm (17¾") aluminium tube.

Colours:

Black, Bronze, Corten, Dark Grey, Olive Green, Silver Star, White Birch, White.

Copper

Body: 63.5mm (2½") x 10mm (3/8") tube.
End cap: solid copper 63.5mm (2½") rod.

Pole: 38.1mm (1½") x 850mm (33½") copper tube.

Retro pole: 38.1mm (1½") x 400mm (15¾") and 63.5mm (2½") x 450mm (17¾") copper tube.

316 Stainless Steel

Body: 63.5mm (2½") x 10mm (3/8") tube.
End cap: solid stainless steel 63.5mm (2½") rod.

Pole: 38.1mm (1½") x 850mm (33½") stainless steel tube.

Retro pole: 38.1mm (1½") x 400mm (15¾") and 63.5mm (2½") x 450mm (17¾") stainless steel tube.

Features

Lens

10mm (3/8") clear flush fit shatter resistant glass.

Lifetime Warranty.

Gaskets

Silicone, iron impregnated 220°C (428°F).

Lamp Holder

MR16 & GU10 - 350°C (662°F) ceramic multi contact lamp holder with 250°C (480°F) Teflon cables.

Accessories

Cable Joint Kit (Cat. CJK150). Not approved for USA/Canada.

Glare Guard (Cat. GG).

Hex Cell Louvre (Cat. HCL).

Frosted Lens (Cat. LENSSTEPF).

Swivel

Aluminium and Copper luminaires - 360° rotation and 0-90° elevation, solid brass with anti rust spring.

Stainless Steel luminaires - 360° rotation and 0-90° elevation, full stainless steel construction.

Standards

IP56/66, UL1838,



Luminaire Weight

12 volt - Aluminium - 1.000kg (2lb 3oz)

Copper - 2.300kg (5lb 1oz)

Stainless Steel - 2.100kg (4lb 10oz)

Retro - Aluminium - 2.100kg (4lb 10oz)

Copper - 3.300kg (7lb 4oz)

Stainless Steel - 3.150kg (6lb 15oz)

Power Supply

12 volt - Hunza Inground or Wall Mount Transformer: not included.

USA and Canada

Hunza Wall Mount Transformer: not included.

Retro - Hunza 110/240-12 volt ac silicone encapsulated electronic transformer is built into the pole.

Dimmable with a suitable dimmer.

Lamp Options

MR16 - 20, 35 or 50 watt lamp max.

GU10 - 25 or 35 watt lamp max.

USA and Canada

MR16 - 20 watt lamp max.

GU10 - lamp not supplied.

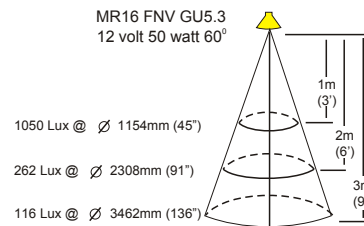
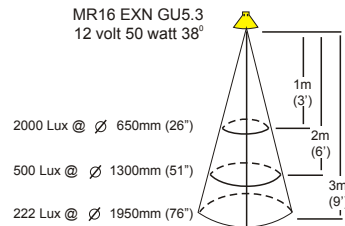
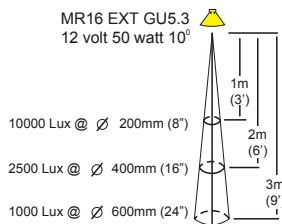
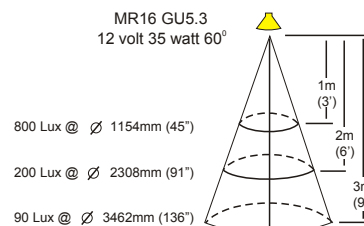
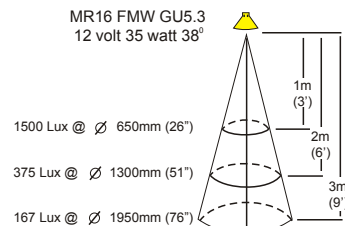
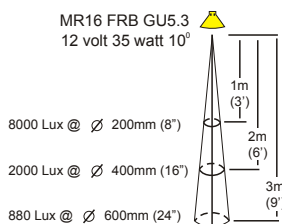
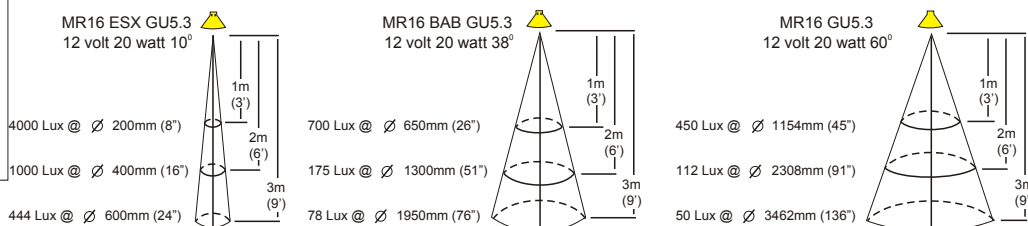

HUNZA™ PURE OUTDOOR LIGHTING

HUNZA FACTORY
130 Felton Mathew Ave
Glen Innes
Auckland 1072
New Zealand

Ph: 64-9-528 9471
Fax: 64-9-528 9361
hunza@hunza.co.nz
www.hunzalighting.com

INTERNATIONAL CONTACTS:
<http://www.hunzalighting.com/contact.php>
Specification may change without notice.
Manufactured in New Zealand.
© 2016 Hunza Holdings Ltd.