

NPS Spot
 Cat. No. NPS
 Cat. No. NPSGU



The NPS Spot is ideal for illuminating bushes and tree from ground level. The luminaire has been designed with a threaded 1/2" NPS base which can be easily fixed to a Hunza Super Spike or Tree Mount Kit. It has a fully adjustable head allowing 360 degree rotation and 0-90 degree elevation.

The luminaire is machined from a choice of solid aluminium with a UV stable powder coated finish, solid copper or 316 stainless steel with a clear, tempered, flush fit, glass lens and high temperature silicone gaskets.

A GU10 version of this luminaire is also available for line voltage lamps. However, a longer luminaire body is needed to accommodate the larger lamp.

Ordering Information

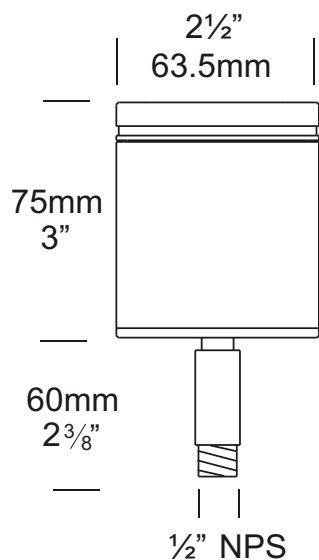

Luminaire Type

- NPS - NPS Spot
- NPSGU - NPS Spot GU10

Material/Finish

- BK - Black
- BZ - Bronze
- CT - Corten
- DG - Dark Grey
- OG - Olive Green
- STAR - Silver Star
- WB - White Birch
- WH - White
- COP - Copper
- SS - Stainless Steel

Accessories

- CJK150 - Cable Joint Kit
- GG - Glare Guard
- HCL - Hex Cell Louvre
- LENSSTEPF - Frosted Lens
- SSP/G - Super Spike
- SSP/T - Tree Mount kit

Ordering Example: NPS BK - NPS Spot in Black
 NPSGU COP - NPS Spot GU10 in Copper
 LENSSTEPF - Frosted Lens
 (accessories ordered separately)

Luminaire Construction

CNC machined from one of the following metals:

Aluminium

High corrosion resistant aluminium with chromate substrate and high UV resistant polyester powder coat. Body: 63.5mm (2½") x 10mm (3/8") tube. End cap: solid aluminium 63.5mm (2½") rod.

Colours:

Black, Bronze, Corten, Dark Grey, Olive Green, Silver Star, White, White Birch.

Copper

Body: 63.5mm (2½") x 10mm (3/8") tube.

End cap: solid copper 63.5mm (2½") rod.

316 Stainless Steel

Body: 63.5mm (2½") x 10mm (3/8") tube.

End cap: solid stainless steel 63.5mm (2½") rod.

Mounting

Designed with a 1/2" NPS thread, this luminaire is easily fitted to a Hunza Super Spike or Tree Mount Kit. It also fits any 1/2" NPS threaded fitting.

Features

Lens

10mm (3/8") clear flush fit shatter resistant glass.

Lifetime Warranty.

Gasket

Silicone, iron impregnated 220°C (428°F).

Lamp Holder

MR16 & GU10 - 350°C (662°F) ceramic multi contact lamp holder with 250°C (480°F) Teflon cables.

Accessories

Cable Joint Kit (Cat. CJK150). Not approved for USA/Canada.

Glare Guard (Cat. GG).

Hex Cell Louvre (Cat. HCL).

Frosted Lens (Cat. LENSSTEPF).

Swivel

Aluminium and Copper luminaires - 360° rotation and 0-90° elevation, solid brass with anti rust spring.

Stainless Steel luminaires - 360° rotation and 0-90° elevation, full stainless steel construction.

Standards

IP68, UL1838, 

Luminaire Weight

Aluminium - 0.450kg (15oz)

Copper - 1.250kg (2lb 12oz)

Stainless Steel - 0.960kg (2lb 1oz)

Power Supply

Hunza Inground or Wall Mount

Transformer: not included.

USA and Canada

Hunza Wall Mount Transformer: not included.

Lamp Options

MR16 - 20 or 35 watt lamp max.

GU10 - 25 or 35 watt lamp max.

USA and Canada

MR16 - 20 watt lamp max.

GU10 - lamp not supplied.

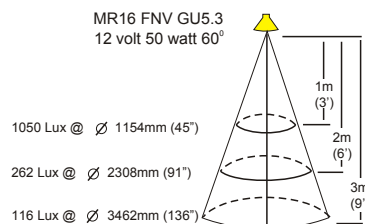
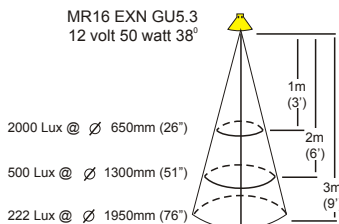
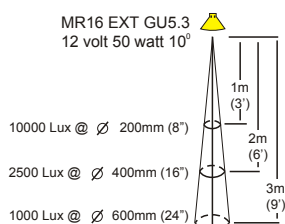
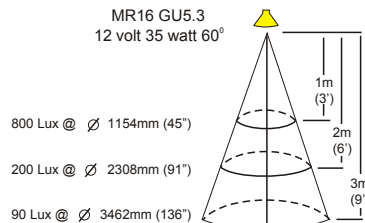
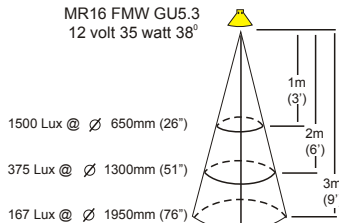
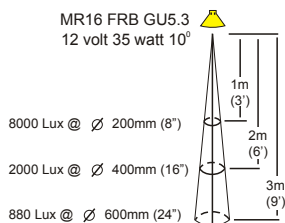
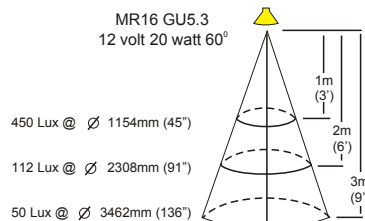
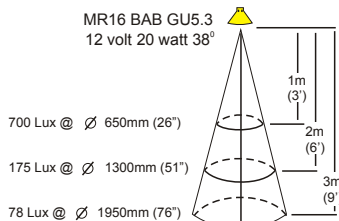
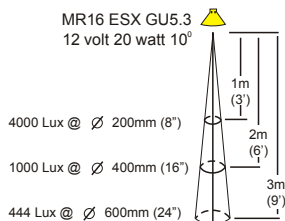

HUNZA™ PURE
OUTDOOR
LIGHTING

HUNZA FACTORY
130 Felton Mathew Ave
Glen Innes
Auckland 1072
New Zealand

Ph: 64-9-528 9471
Fax: 64-9-528 9361
hunza@hunza.co.nz
www.hunzalighting.com

INTERNATIONAL CONTACTS:
[http://www.hunzalighting.com/
contact.php](http://www.hunzalighting.com/contact.php)
Specification may change without notice.
Manufactured in New Zealand.
© 2016 Hunza Holdings Ltd.