

Type reference : E 30 TP 263

European standard :

EN 61 558-2-6 (1997)

General data :

single-phase safety isolating transformer
protection against electric shock : class II
degree of protection to EN 60 529 : IP67
non short-circuit proof transformer
rated maximum ambient temperature : ta 40°C
temperature class according to IEC 60 085 : E

Electrical values :

rated voltages : input : 240 V
output : 11,6 V
no - load output : 12,2 V
rated frequency : 50-60 Hz
rated current : output 16,4 A
total losses : 18,9 Watt
efficiency : 91%

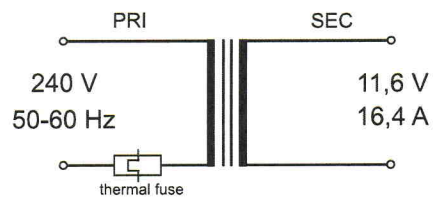

Marking :



Constructional data :

in plastic case
vacuum-encapsulated with synthetic resin
connection : input : polychloropren cable
H05 RN-F 2 x 0,75 mm²
color : black
length : 1 m
output : polychloropren cable
H07 RN-F 2 x 2,5 mm²
color : black
length : 1 m

Dimensions and weight :

dimensions : 105 x 88 x 110 mm
weight : 3,7 kg

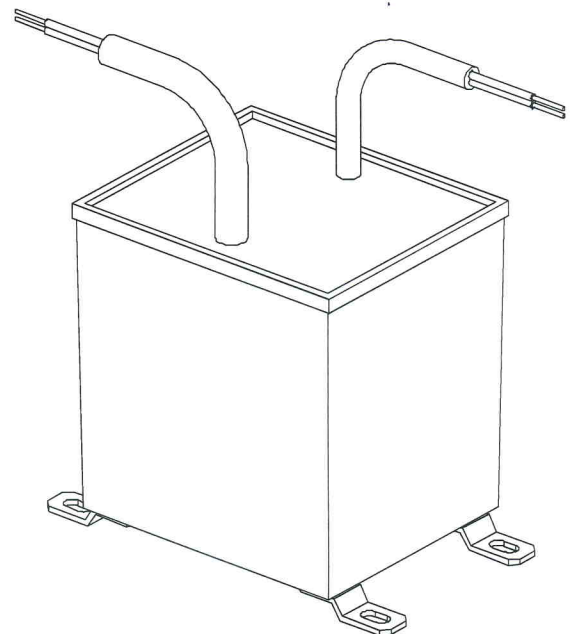

				Datasheet	
000		27/05/05		Safety isolating transformer	1 / 1
				E 30 TP 263	