

Twig Lite

PROJECT:
TYPE:
SOURCE:
NOTES:

PURELED SPECIFICATIONS

LED Chip	Cree XPG-3 Plug and Play field replaceable LED board
Luminaire Output	120 Lumens @ 700mA (2 watts), delivered from luminaire with unobstructed beam.
Lumens Per Watt	60 Lumens minimum @ 2 watts, delivered from luminaire with unobstructed beam
CRI (3000K)	85+ Standard, 90+ Optional
Colour Temperatures	2700K, 3000K, 4000K
Beam Angles	Asymmetric
Ingress Protection	IP44

Warranty	Electronics = 5 years Body Cop/SS = 10 years
Standards	AS/NZS 61046 cUL 1838, 2108 CSA C22.2 No.250.7, No.250.0-08 CE

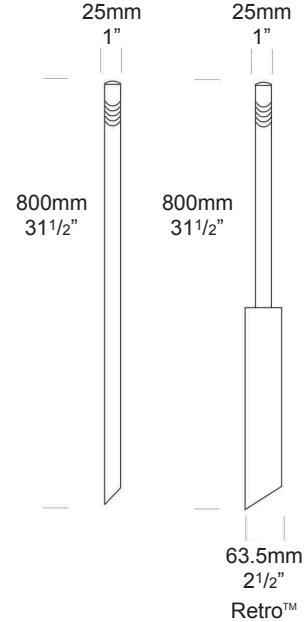

PRODUCT CONFIGURATION

Please fill in appropriate codes into boxes provided

Cat. No. TG/L

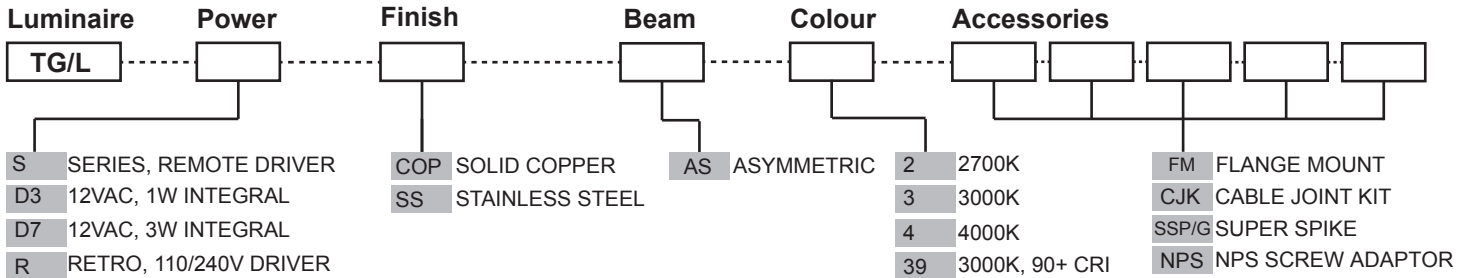

SERIES, REMOTE DRIVER REQUIRED:
Constant current driver
Individual fixtures require 3vdc @ 700mA maximum

12VAC INTEGRAL DRIVER:
Hunza Buckbullet driver (included)
Input: 12VAC, 2watt at 700mA
Output: 6vdc @ D3=350mA, D7=700mA

110/240VAC RETRO DRIVER:
Input: 120/240vac, 2 watt total (included)
Output: 3vdc, 700mA
0-10 volt dimming (USA - non dimming)

[Click here for halogen specification sheet](#)

OTHER LAMP OPTIONS
TG /H - G4 Halogen 12V Lamp
TG /GL - G4 LED Retrofit 12V Lamp (lamps vary by market - please refer to supplier for details)

[Click for here Remote Power Supply Guidance Charts](#)

LUMINAIRE CONSTRUCTION

CNC machined from one of the following

metals:

Copper

Pole: solid copper 25.4mm (1") rod.

End cap: solid copper 25.4mm (1") rod.

316 Stainless Steel

Pole: 316 stainless steel 25.4mm (1") rod.

End cap: 316 stainless steel 25.4mm (1") rod.

Lens:

22mm (3/4") extra clear low iron flush fit shatter resistant glass tube.

Lifetime warranty.

Mounting

The pole 800mm (31½") is directly mounted into the earth or concrete. For extra stability in sand or loose ground use the Super Spike. Flange Mount option is available for hard surfaces.

Luminaire Weight:

Low voltage

Cop: 0.800kg (1lb 12oz)

SS: 0.800kg (1lb 12oz)

Retro™

Cop: 1.980kg (4lb 6oz)

SS: 1.980kg (4lb 6oz)

Gaskets:

Silicone, iron impregnated 220°C (428°F).

ACCESSORIES

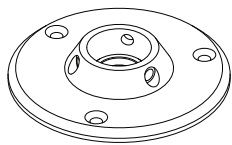

Flange Mount

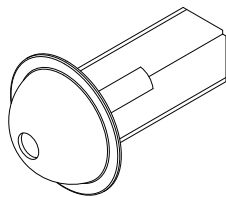

Super Spike

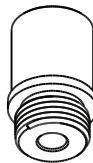

NPS 1/2"
Screw Mount Adaptor

BEAM ANGLES

High efficiency PMMA TIR lenses. Field replaceable

IES files available for download: hunzalighting.com/downloads

WIRING GUIDE

Series/remote driver

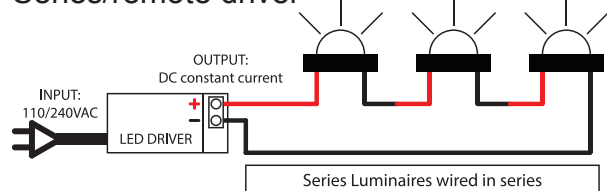

Diagrams are a guide only, wire colours and polarity may change depending on fixture and country

Available for download: hunzalighting.com/downloads

12v integral driver

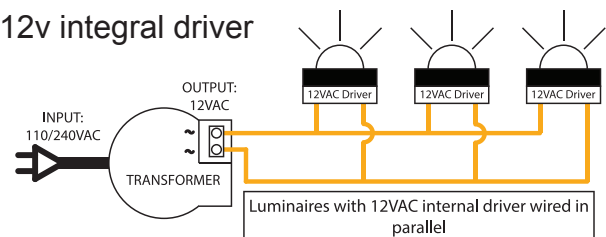

Specifications may change without notification

Aug 2017

HUNZA™ PURE
OUTDOOR
LIGHTING

HUNZA FACTORY

130 Felton Mathew Ave
Saint Johns
Auckland 1072
New Zealand

Ph: +64-9-528 9471
Fax: +64-9-528 9361
hunza@hunza.co.nz
www.hunzalighting.com

INTERNATIONAL CONTACTS:

<http://www.hunzalighting.com/contact.php>

This document contains proprietary information of Hunza. Its receipt or possession does not convey any rights to reproduce or disclose its content.